

# QJ321N2.MPA

## Dimensions and Parameters

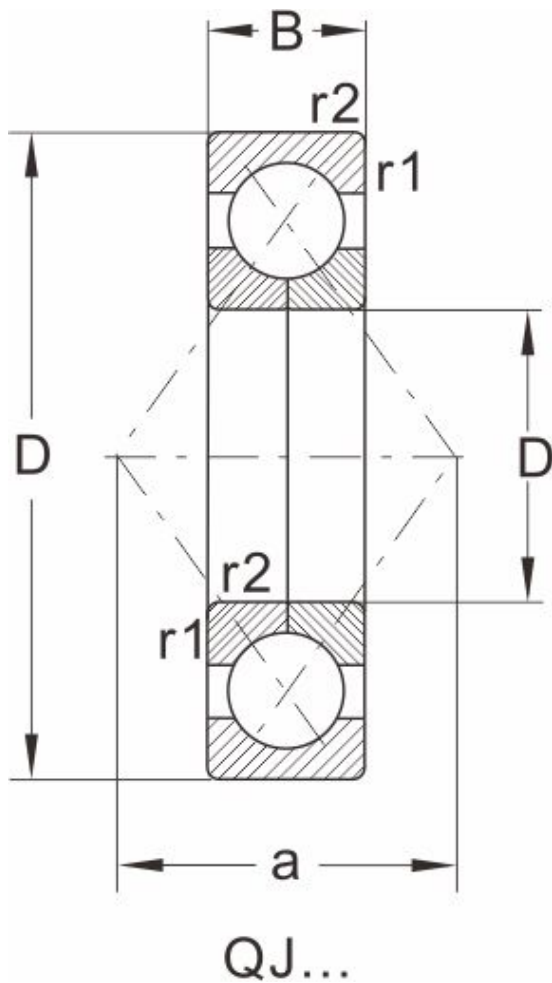

Designation	QJ321N2.MPA
Boundary dimensions [mm]	
d	105
D	225
B	49
r1,r2 Min	3
a	116
an	11.7
bn	10.5
rn	2
Load ratings (kN)	
dyn Cr	344
stat Cor	406
Speed ratings (rpm)	
grease	2200
oil	3200
Mass	
Kg	10.5