

# QJ318 N2.MPA

## Dimensions and Parameters

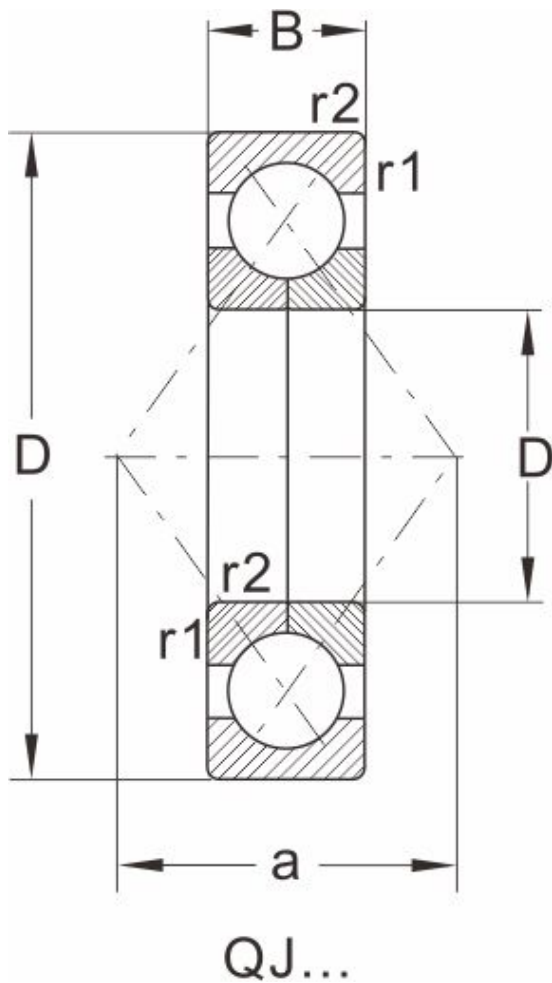

Designation	QJ318 N2.MPA
Boundary dimensions [mm]	
d	90
D	190
B	43
r1,r2 Min	3
a	98
an	11.7
bn	10.5
rn	2
Load ratings (kN)	
dyn Cr	267
stat Cor	283
Speed ratings (rpm)	
grease	2800
oil	3800
Mass	
Kg	6.34