

QJ312.MPA

Dimensions and Parameters

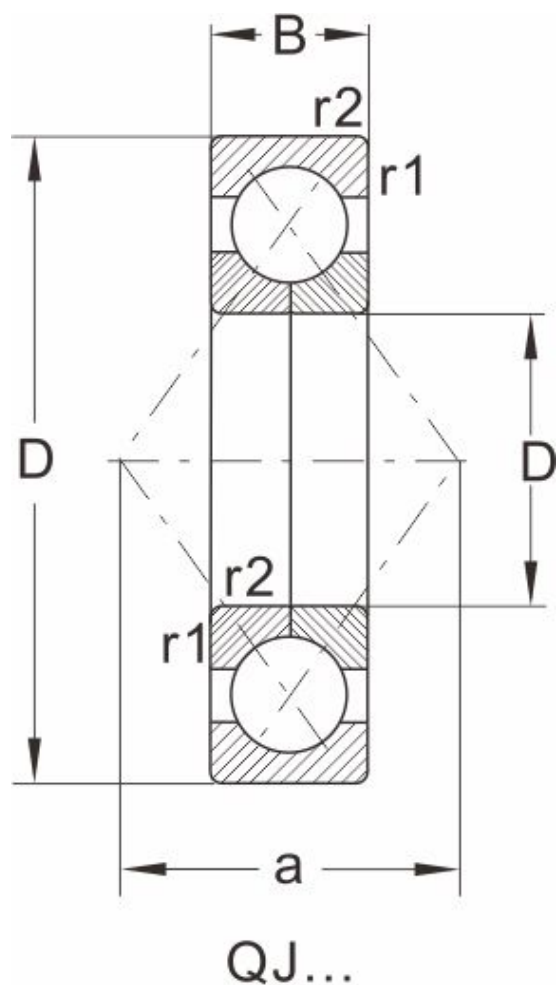

Designation	QJ312.MPA
Boundary dimensions [mm]	
d	60
D	130
B	31
r1,r2 Min	2.1
a	67
an	--
bn	--
rn	--
Load ratings (kN)	
dyn Cr	154
stat Cor	134
Speed ratings (rpm)	
grease	1300
oil	5600
Mass	
Kg	2.18