

QJ240N2.MPA

Dimensions and Parameters

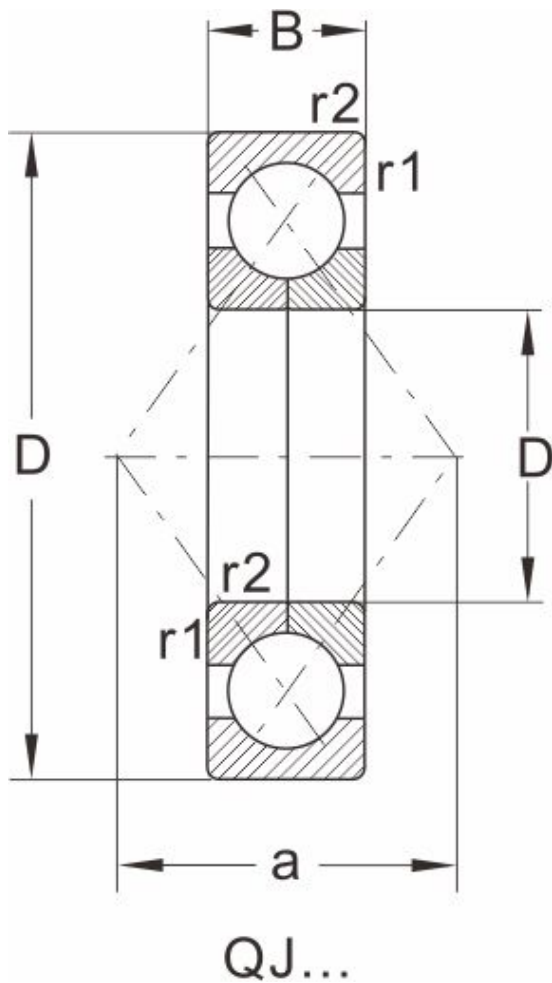

Designation	QJ240N2.MPA
Boundary dimensions [mm]	
d	200
D	360
B	58
r1,r2 Min	4
a	196
an	12.7
bn	10.5
rn	2
Load ratings(kN)	
dyn Cr	507
stat Cor	850
Speed ratings(rpm)	
grease	1300
oil	1800
Mass	
Kg	28.5