

QJ238N2.MPA

Dimensions and Parameters

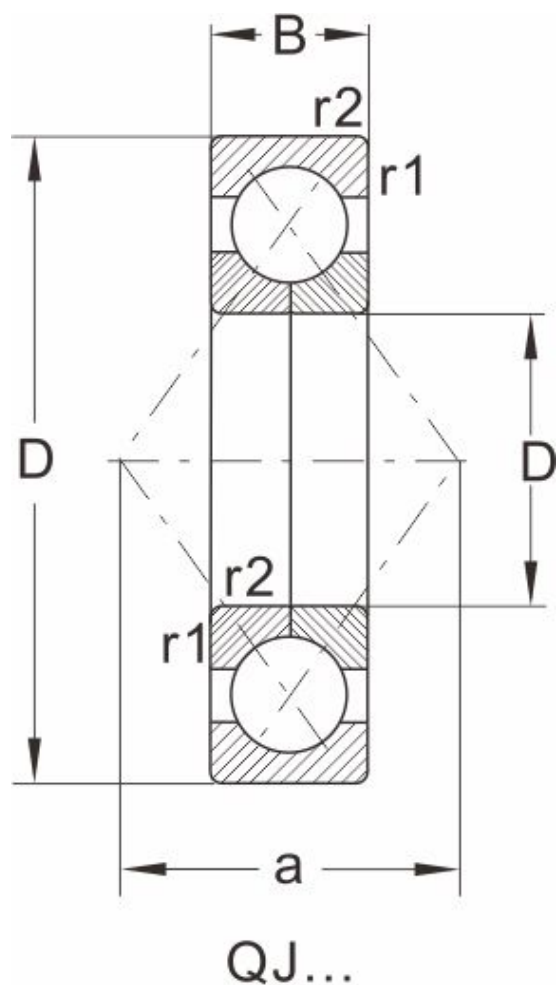

Designation	QJ238N2.MPA
Boundary dimensions [mm]	
d	190
D	340
B	55
r1,r2 Min	4
a	186
an	12.7
bn	10.5
rn	2
Load ratings (kN)	
dyn Cr	488
stat Cor	780
Speed ratings (rpm)	
grease	1400
oil	1900
Mass	
Kg	24.5