

# QJ226N2.MPA

## Dimensions and Parameters

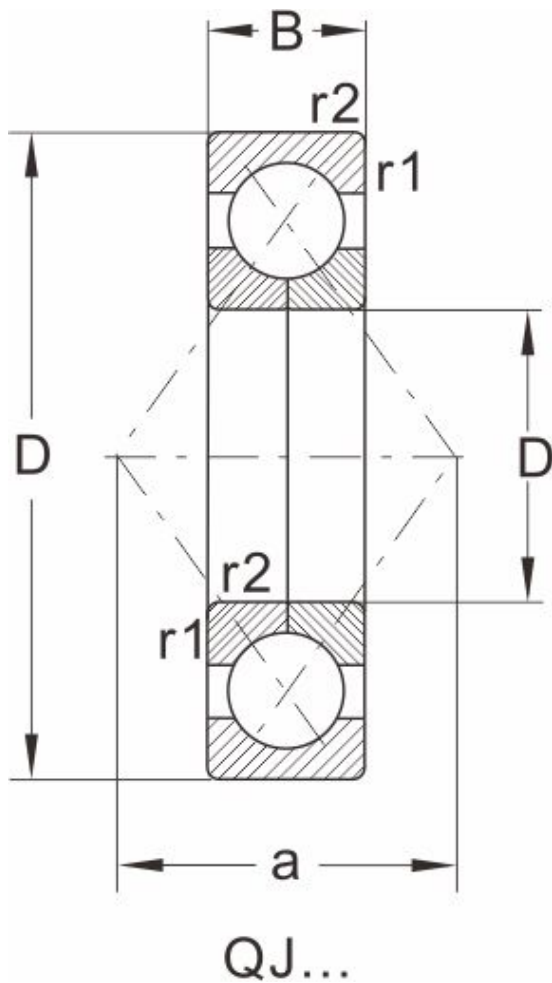

Designation	QJ226N2.MPA
Boundary dimensions [mm]	
d	130
D	230
B	40
r1,r2 Min	3
a	126
an	11.7
bn	10.5
rn	2
Load ratings(kN)	
dyn Cr	296
stat Cor	365
Speed ratings(rpm )	
grease	1900
oil	2800
Mass	
Kg	7.75