

# QJ221N2.MPA

## Dimensions and Parameters

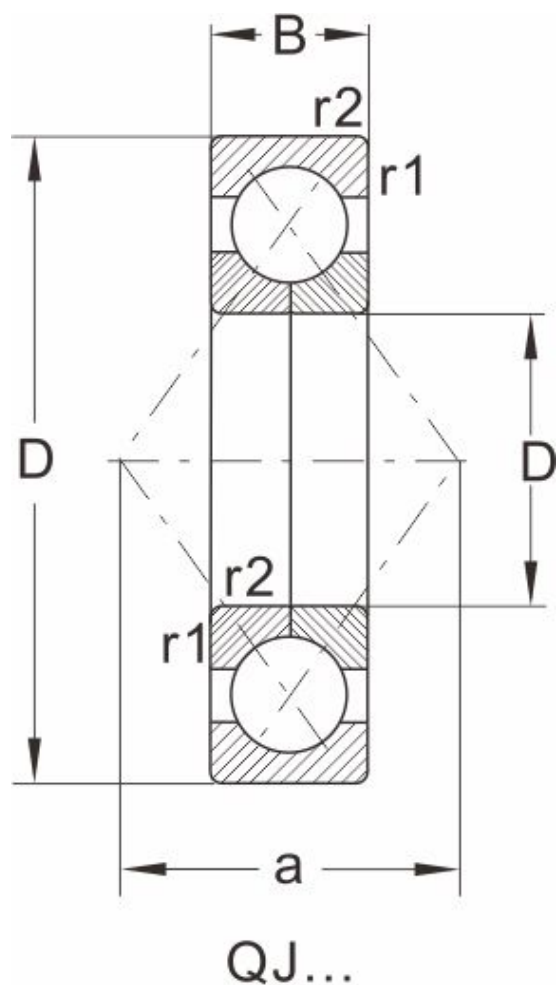

Designation	QJ221N2.MPA
Boundary dimensions [mm]	
d	105
D	190
B	36
r1,r2 Min	2.1
a	103
an	10.1
bn	8.5
rn	2
Load ratings (kN)	
dyn Cr	242
stat Cor	270
Speed ratings (rpm)	
grease	2600
oil	3600
Mass	
Kg	4.8