

# QJ220N2.MPA

## Dimensions and Parameters

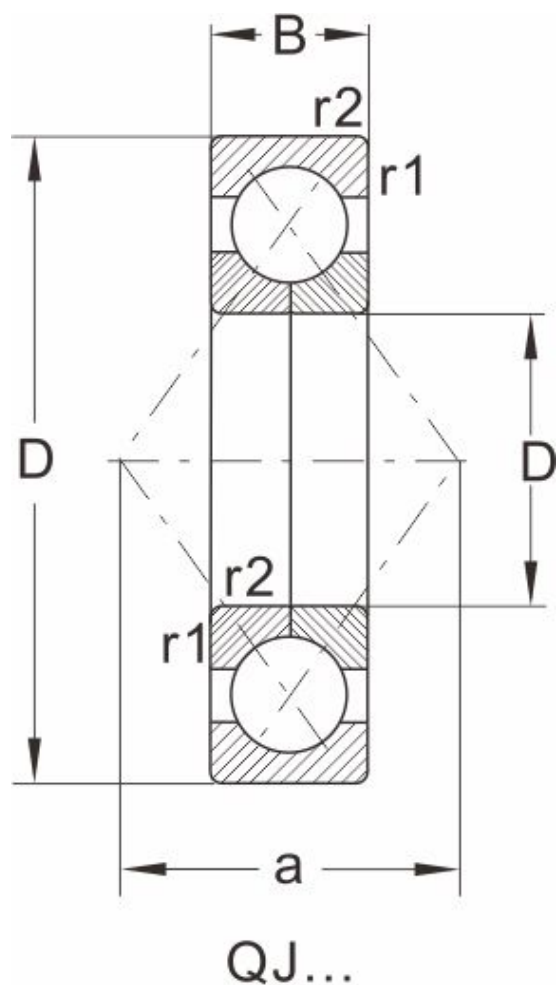

Designation	QJ220N2.MPA
Boundary dimensions [mm]	
d	100
D	180
B	34
r1,r2 Min	2.1
a	98
an	10.1
bn	8.5
rn	2
Load ratings (kN)	
dyn Cr	225
stat Cor	240
Speed ratings (rpm)	
grease	2800
oil	3800
Mass	
Kg	4.05