

QJ212.MPA

Dimensions and Parameters

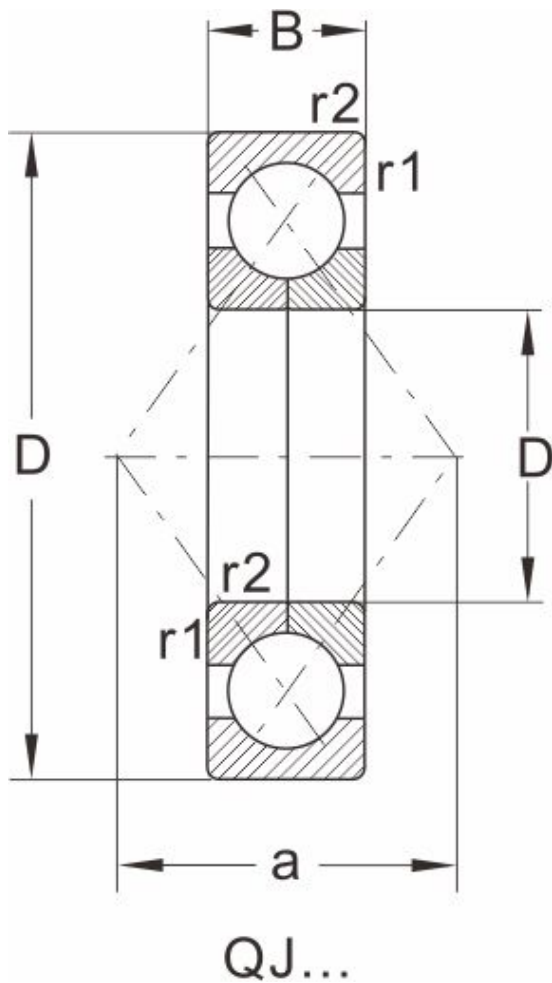

Designation	QJ212.MPA
Boundary dimensions [mm]	
d	60
D	110
B	22
r1,r2 Min	1.5
a	60
an	--
bn	--
rn	--
Load ratings(kN)	
dyn Cr	92
stat Cor	87
Speed ratings(rpm)	
grease	4800
oil	6300
Mass	
Kg	0.87