

QJ1272N2.MPA

Dimensions and Parameters

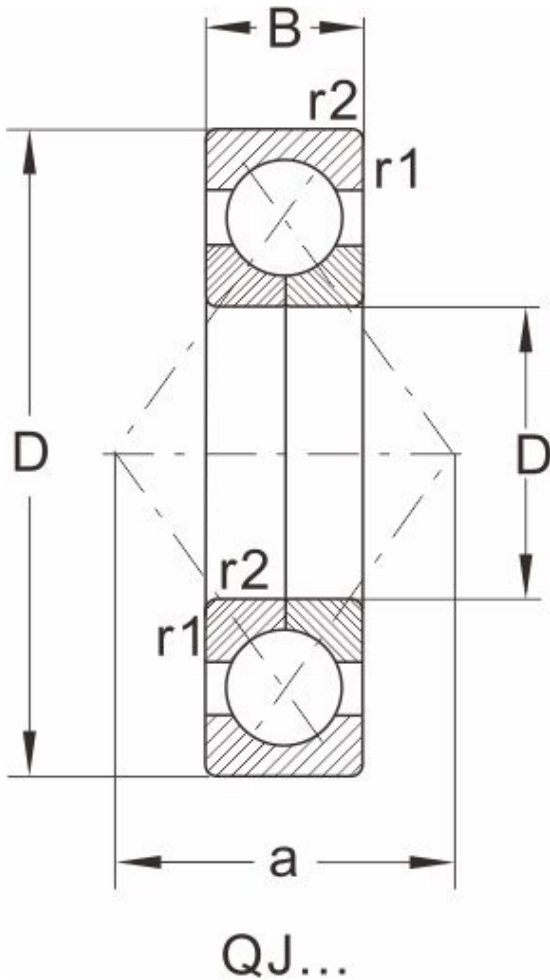

Designation	QJ1272N2.MPA
Boundary dimensions [mm]	
d	360
D	650
B	122
r1,r2 Min	6
a	329
an	25
bn	20.5
rn	--
Load ratings(kN)	
dyn Cr	1110
stat Cor	2600
Speed ratings(rpm)	
grease	700
oil	950
Mass	
Kg	160