

QJ1096N2.MPA

Dimensions and Parameters

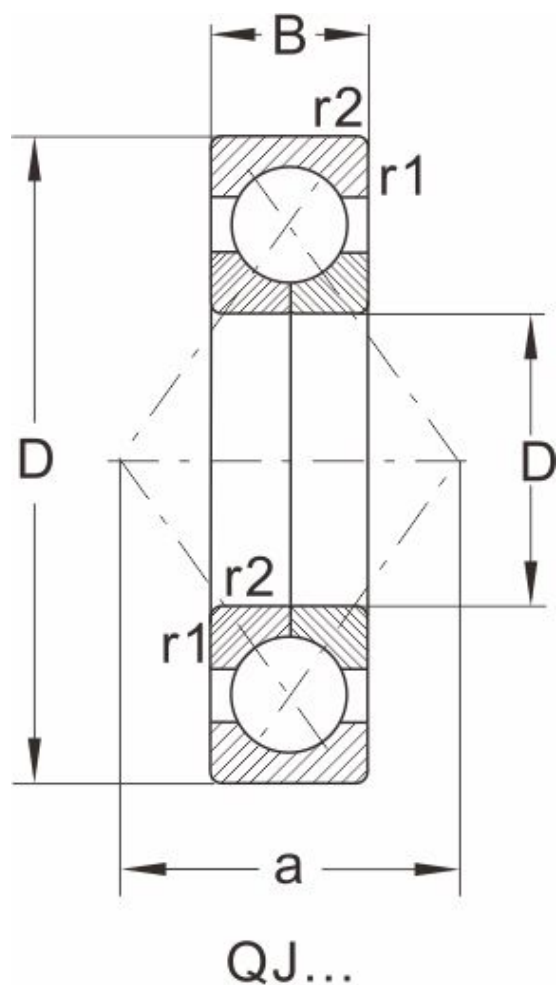

Designation	QJ1096N2.MPA
Boundary dimensions [mm]	
d	480
D	700
B	100
r1,r2 Min	6
a	413
an	20
bn	15.5
rn	--
Load ratings(kN)	
dyn Cr	1060
stat Cor	2800
Speed ratings(rpm)	
grease	560
oil	750
Mass	
Kg	135