

# QJ1080N2.MPA

## Dimensions and Parameters

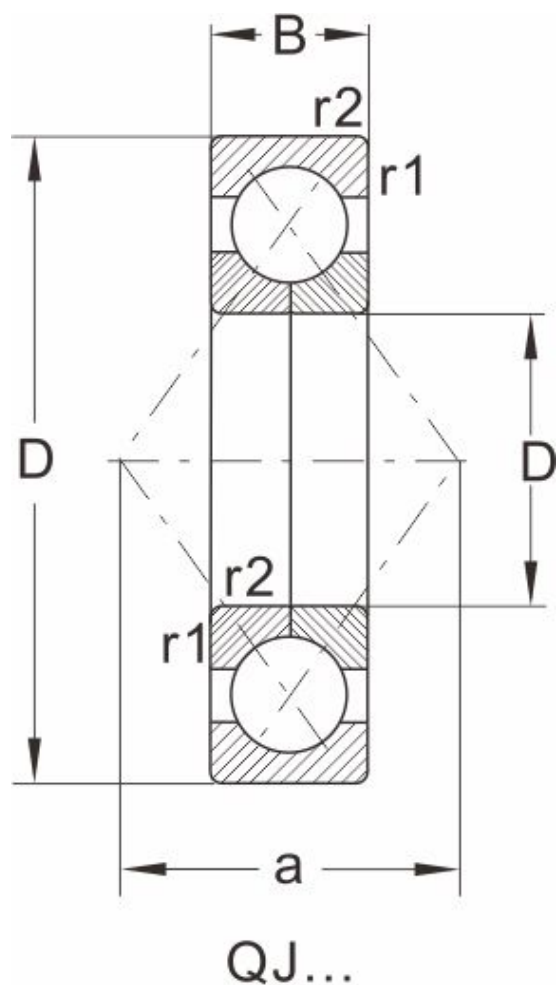

Designation	QJ1080N2.MPA
Boundary dimensions [mm]	
d	400
D	600
B	90
r1,r2 Min	5
a	343
an	15
bn	12.5
rn	--
Load ratings(kN)	
dyn Cr	904
stat Cor	2160
Speed ratings(rpm )	
grease	700
oil	950
Mass	
Kg	95.5