

# QJ1072N2.MPA

## Dimensions and Parameters

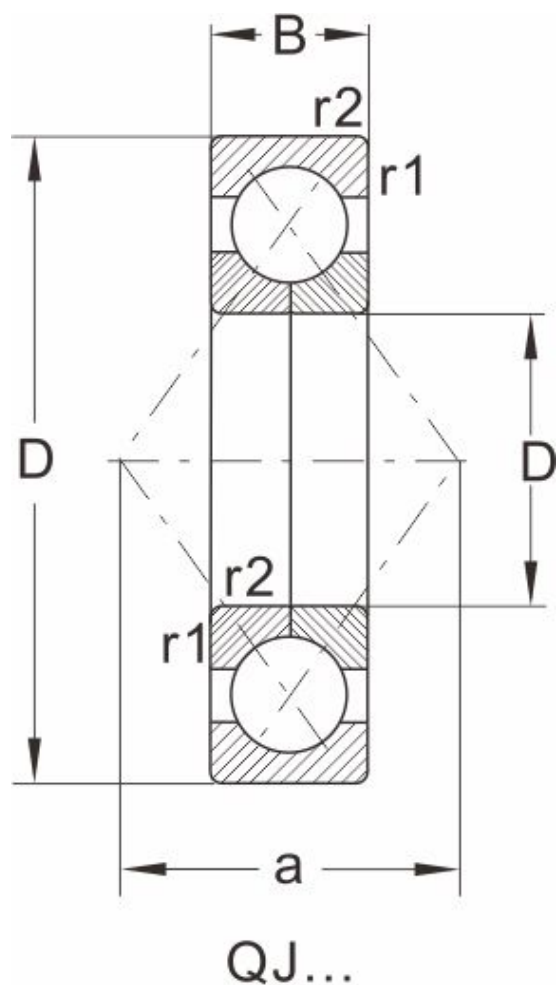

Designation	QJ1072N2.MPA
Boundary dimensions [mm]	
d	360
D	540
B	82
r1,r2 Min	5
a	505
an	15
bn	12.5
rn	--
Load ratings(kN)	
dyn Cr	793
stat Cor	1800
Speed ratings(rpm )	
grease	800
oil	1100
Mass	
Kg	70.5