

QJ1064N2.MPA

Dimensions and Parameters

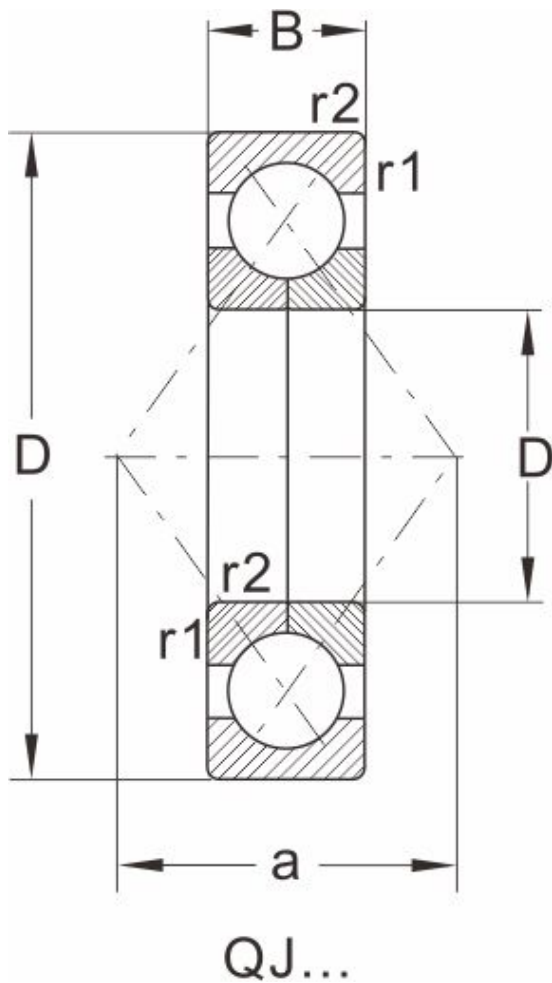

Designation	QJ1064N2.MPA
Boundary dimensions [mm]	
d	320
D	480
B	74
r1,r2 Min	4
a	280
an	15
bn	12.5
rn	--
Load ratings(kN)	
dyn Cr	663
stat Cor	1400
Speed ratings(rpm)	
grease	850
oil	1200
Mass	
Kg	50