

# QJ1040N2.MPA

## Dimensions and Parameters

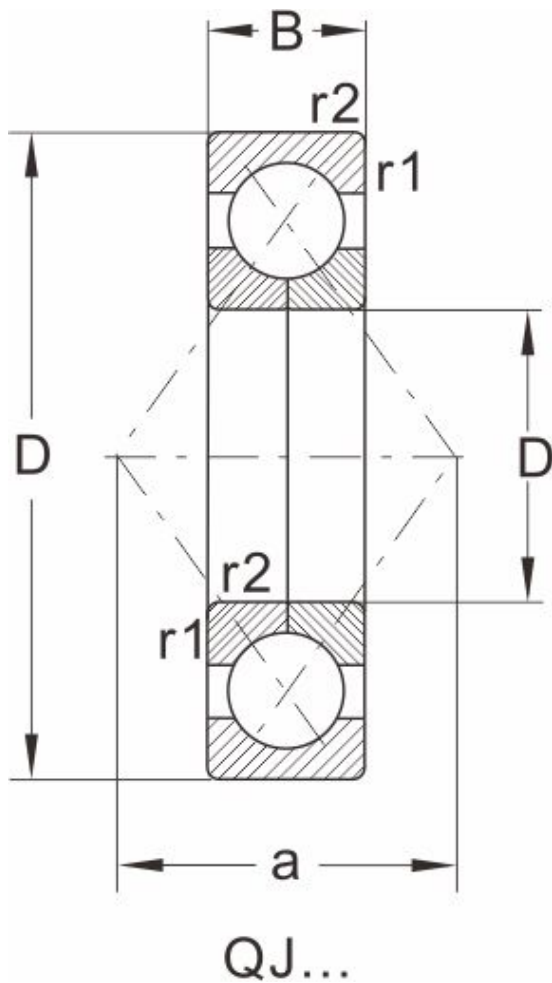

Designation	QJ1040N2.MPA
Boundary dimensions [mm]	
d	200
D	310
B	51
r1,r2 Min	2.1
a	179
an	12.7
bn	10.5
rn	2
Load ratings(kN)	
dyn Cr	390
stat Cor	620
Speed ratings(rpm )	
grease	1500
oil	2000
Mass	
Kg	14.7