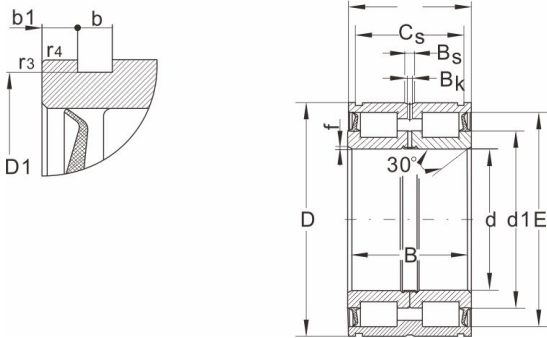

**NNF5018.2LS.V****Dimensions and Parameters**

Bearing No.	NNF5018.2LS.V
-------------	---------------

## Boundary dimensions [mm]

d	90
D	140
B	67
C	66
CS	59.2
r3,r4 Min	0.6

## Basic load ratings (kN)

Dynamic (Cr)	297
Static (Cor)	552
Limiting speed (rpm)	900

## Bearing dimensions

d1	109
D1	137
b	4.2
b1	3.4
Bs	5
Bk	3.5
f	1.5
C1 <sup>1)</sup> +0.1	54
C2 <sup>2)</sup> +0.1	51

## Stop ring

WRE	WRE140
to DIN 471	140×4
Weight	3.8