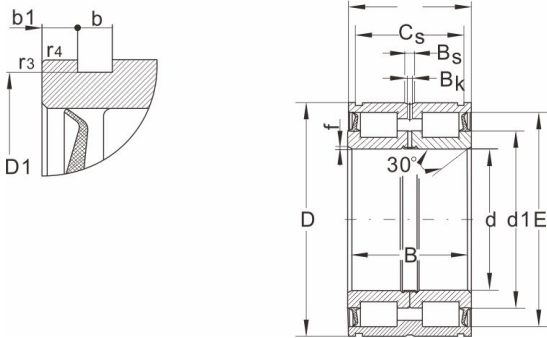

**NNF5013.2LS.V****Dimensions and Parameters**

Bearing No.	NNF5013.2LS.V
-------------	---------------

## Boundary dimensions [mm]

d	65
D	100
B	46
C	45
CS	40.2
r3,r4 Min	0.6

## Basic load ratings (kN)

Dynamic(Cr)	128
Static(Cor)	224
Limiting speed(rpm)	1300

## Bearing dimensions

d1	78
D1	97.4
b	3.2
b1	2.4
Bs	4.5
Bk	3.5
f	1
C1 <sup>1)</sup> +0.1	35
C2 <sup>2)</sup> +0.1	34

## Stop ring

WRE	WRE100
to DIN 471	100×3
Weight	1.3