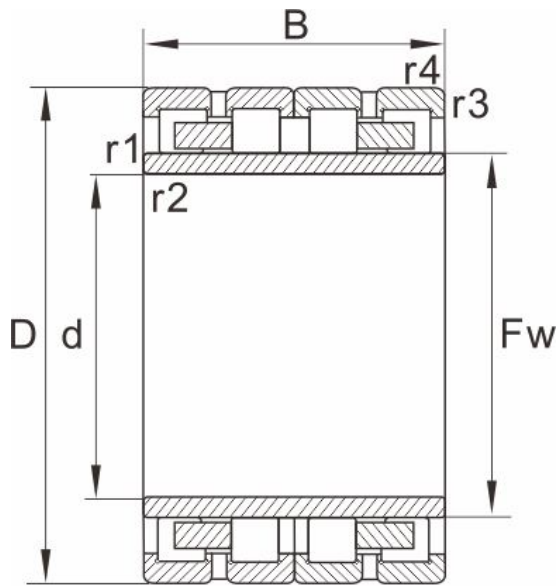

FC182870**Dimensions and Parameters**

FC

Bearing No.	FC182870
Boundary dimensions(mm)	
d	90
D	140
B	70
Fw	105
r1.2min	1.5
r3.4min	1.5
Draw	2

Basic load ratings(kN)

Dynamic(Cr)	242
Static(Cor)	425
Weight (kg)	3.78

Reference model

SKF	
FAG	
NTN	
NSK	
KOYO	