

7210AC

Dimensions and Parameters

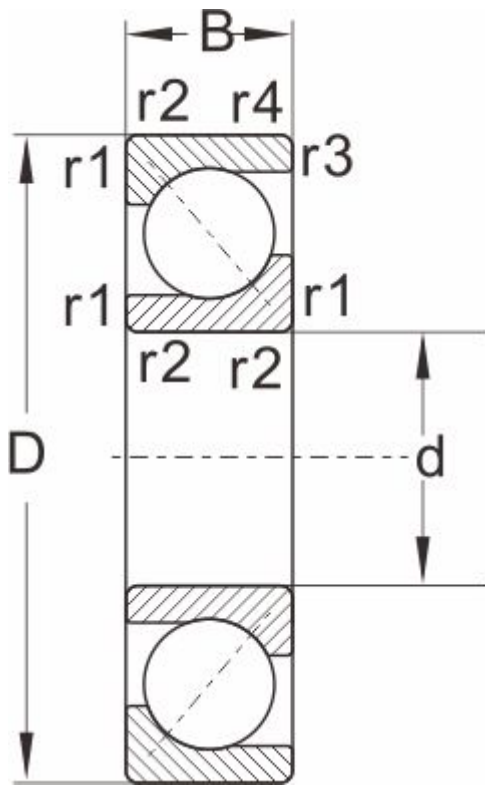

Designations	7210AC
Boundary dimensions	
d	50
D	90
B	20
r1,r2 Min	1.1
a ≈	0.6
Load ratings[KN]	
Dynmic Cr	40.8
stat Cor	30.3
Speed ratings[rpm]	
grease	6300
oil	8500
Mass	0.46