

# 7060BM

## Dimensions and Parameters

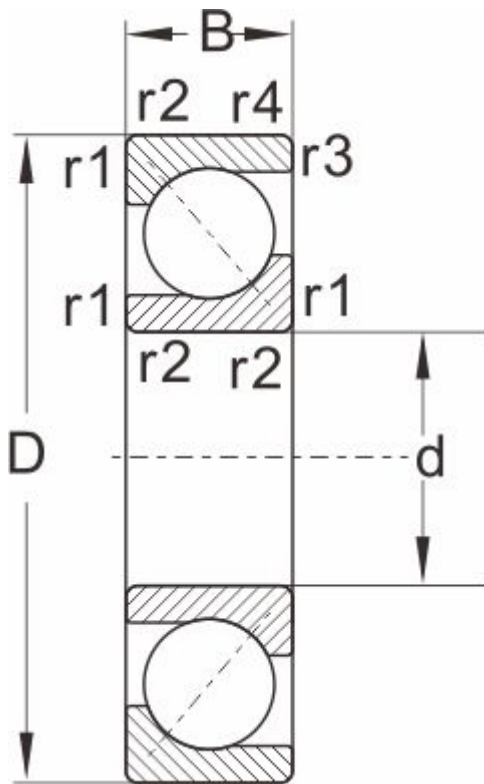

Designations	7060BM
Boundary dimensions	
d	300
D	460
B	74
r1,r2 Min	4
a ≈	1.5
Load ratings[KN]	
Dynmic Cr	345
stat Cor	545
Speed ratings[rpm]	
grease	950
oil	1400
Mass	44.5