

7010AC

Dimensions and Parameters

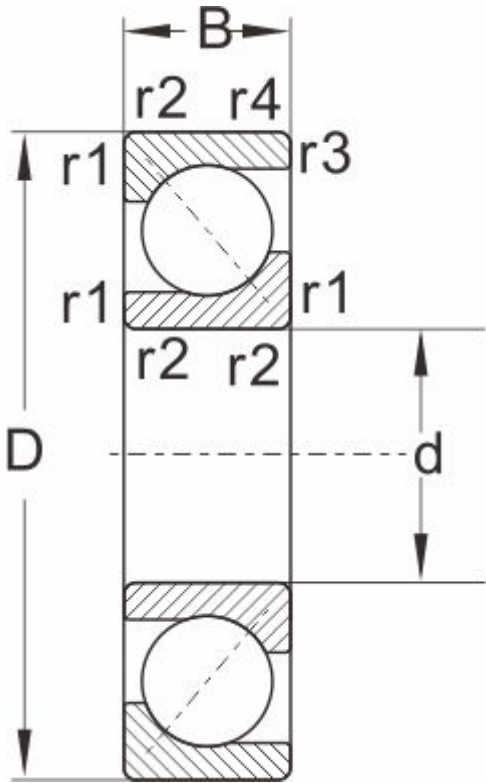

Designations	7010AC
Boundary dimensions	
d	50
D	80
B	16
r1,r2 Min	1
a ≈	0.3
Load ratings[KN]	
Dynmic Cr	25.2
stat Cor	21.4
Speed ratings[rpm]	
grease	6700
oil	9000
Mass	0.257