

6021N

Dimensions and Parameters

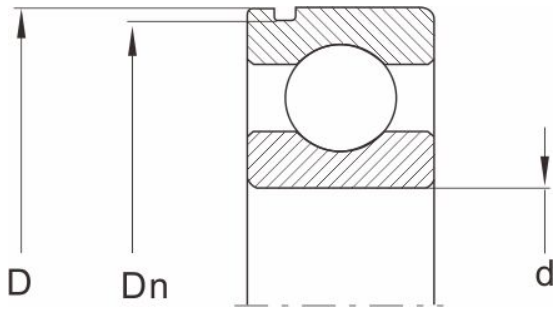

Designation Bearing series

60	6021N
62	6218N
63	6315N
64	6413N
D	160

Dn

min.	154.72
max.	155.22

a Bearing series 60

min.	3.46
max.	3.71

a Bearing series 62 63 64

min.	4.65
max.	4.9

b

min.	3.1
max.	3.4

r0

max.	0.6
------	-----

Stop ring

D	SP160
---	-------

f

min.	2.72
max.	2.82

e

Single Row Deep Groove Ball Bearings with Snap Ring Groove and Snap

Ring

min.

7.06

max.

7.21

g

≈

7

DR

max

169.7

DG

min

172