

6005N

Dimensions and Parameters

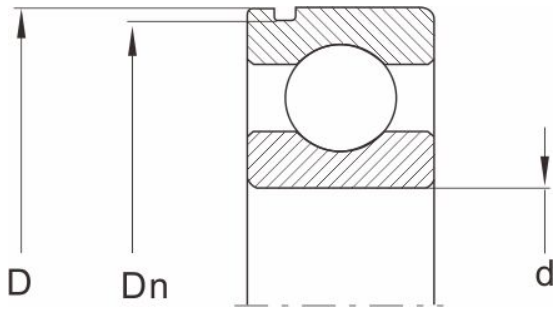

Designation Bearing series

60	6005N
62	6204N
63	6303N
64	--
D	47

Dn

min.	44.35
max.	44.6

a Bearing series 60

min.	1.9
max.	2.06

a Bearing series 62 63 64

min.	2.31
max.	2.46

b

min.	1.35
max.	1.65

r0

max.	0.4
------	-----

Stop ring

D	SP47
---	------

f

min.	1.02
max.	1.12

e

Single Row Deep Groove Ball Bearings with Snap Ring Groove and Snap

Ring

min.

3.89

max.

4.04

g

≈

4

DR

max

52.7

DG

min

53.5