

32976

Dimensions and Parameters

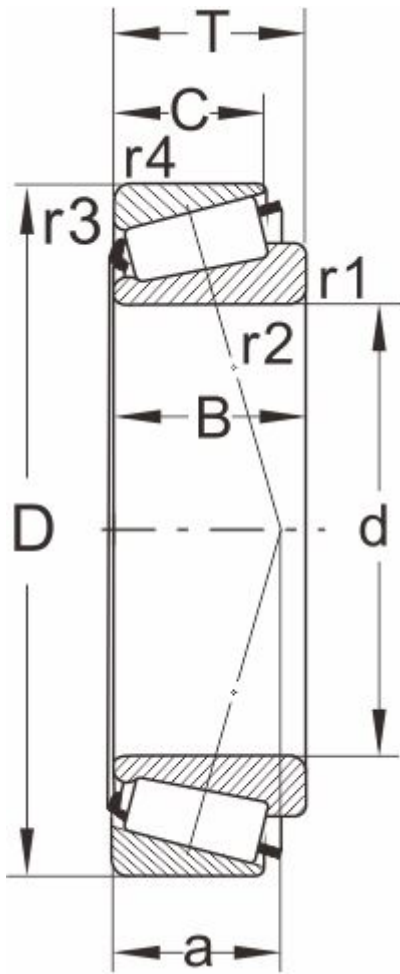

Designation

DIN720	32976
ISO355	--

Boundary dimensions(mm)

d	380
D	520
B	82
C	71
T	87
r1,r2 min	5
r3,r4 min	4
a	--

Speed ratings

grease	560
oil	750

Load ratings[kN]

dyn Cr	1210
stat Cor	2550

Calculation factors

e	0.39
Y	1.6
Y0	0.86

Abutment and fillet

dimensions(mm)

Da max	418
db min	396

Single Row Tapered Roller Bearings (Metric Series)

Da min	487
Db min	501
Ca min	--
Cb min	--
Mass (kg)	49.5