

32968

Dimensions and Parameters

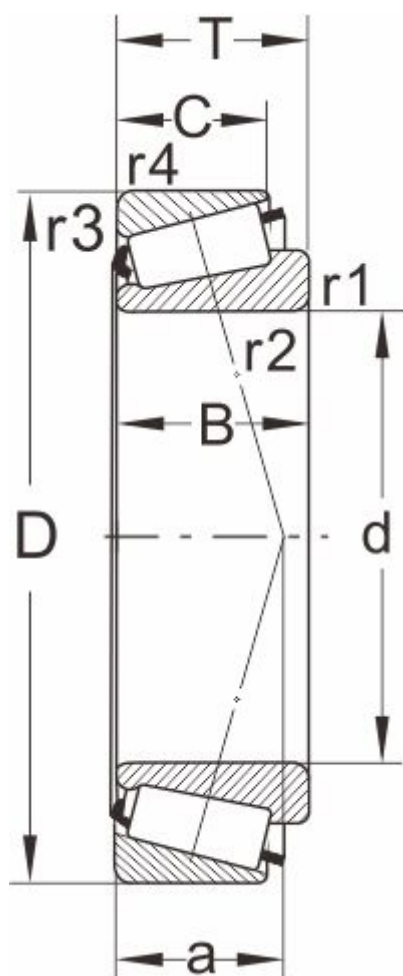

Designation

DIN720	32968
ISO355	--

Boundary dimensions(mm)

d	340
D	460
B	76
C	57
T	76
r1,r2 min	4
r3,r4 min	3
a	--

Speed ratings

grease	630
oil	850

Load ratings[kN]

dyn Cr	1040
stat Cor	2450

Calculation factors

e	0.44
Y	1.4
Y0	0.8

Abutment and fillet

dimensions(mm)

Da max	357
db min	361

Single Row Tapered Roller Bearings (Metric Series)

Da min	440
Db min	446
Ca min	--
Cb min	--
Mass (kg)	33.6