

32348

Dimensions and Parameters

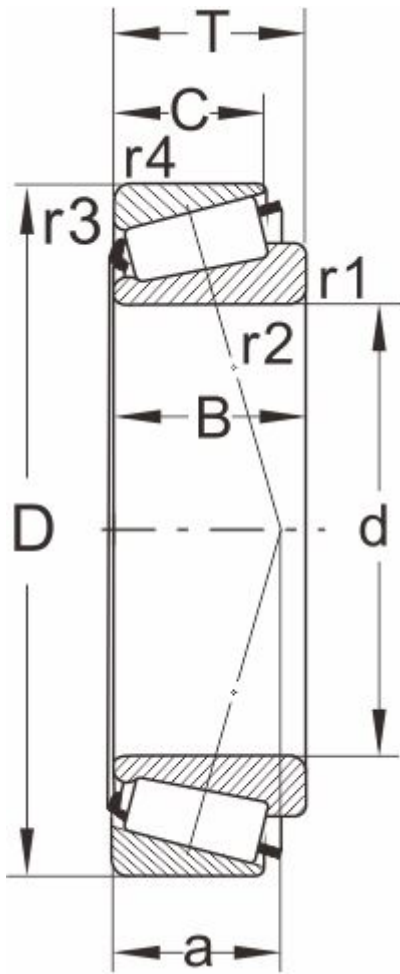

Designation

DIN720	32348
ISO355	--

Boundary dimensions(mm)

d	240
D	500
B	155
C	132
T	165
r1,r2 min	6
r3,r4 min	5
a	--

Speed ratings

grease	700
oil	950

Load ratings[kN]

dyn Cr	2520
stat Cor	4100

Calculation factors

e	0.37
Y	1.6
Y0	0.88

Abutment and fillet

dimensions(mm)

Da max	307
db min	273

Single Row Tapered Roller Bearings (Metric Series)

Da min	444
Db min	479
Ca min	--
Cb min	--
Mass (kg)	145