

32208

Dimensions and Parameters

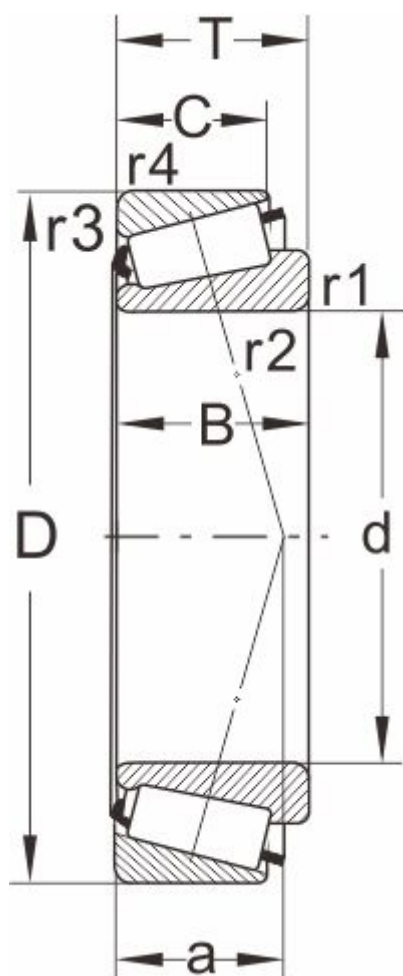

Designation

DIN720	32208
ISO355	T3DC040

Boundary dimensions(mm)

d	40
D	80
B	23
C	19
T	24.75
r1,r2 min	1.5
r3,r4 min	1.5
a	19

Speed ratings

grease	4800
oil	6300

Load ratings[kN]

dyn Cr	80
stat Cor	95

Calculation factors

e	0.37
Y	1.6
Y0	0.88

Abutment and fillet

dimensions(mm)

Da max	48
db min	47

Single Row Tapered Roller Bearings (Metric Series)

Da min	68
Db min	75
Ca min	3
Cb min	5.5
Mass (kg)	0.56