

32207

Dimensions and Parameters

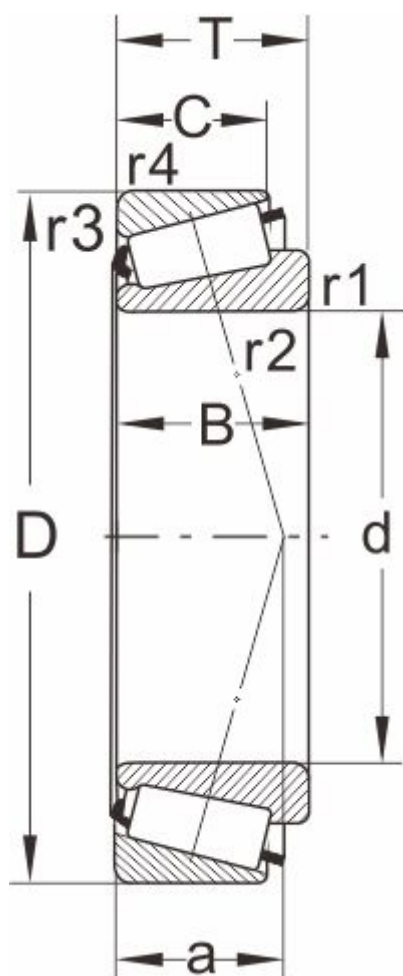

Designation

DIN720	32207
ISO355	T3DC035

Boundary dimensions(mm)

d	35
D	72
B	23
C	19
T	24.25
r1,r2 min	1.5
r3,r4 min	1.5
a	18

Speed ratings

grease	5300
oil	7000

Load ratings[kN]

dyn Cr	71
stat Cor	85

Calculation factors

e	0.37
Y	1.6
Y0	0.88

Abutment and fillet

dimensions(mm)

Da max	43
db min	42

Single Row Tapered Roller Bearings (Metric Series)

Da min	61
Db min	67
Ca min	3
Cb min	5.5
Mass (kg)	0.43