

30334

Dimensions and Parameters

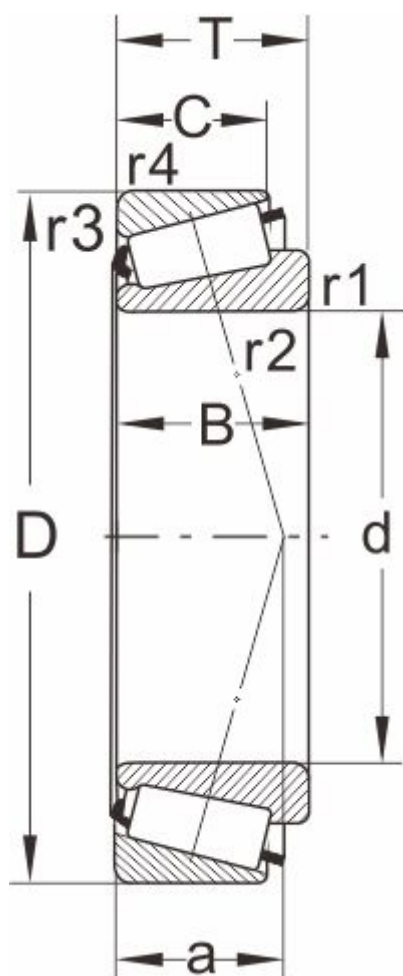

Designation

DIN720	30334
ISO355	--

Boundary dimensions(mm)

d	170
D	360
B	72
C	62
T	80
r1,r2 min	5
r3,r4 min	4
a	--

Speed ratings

grease	950
oil	1400

Load ratings[kN]

dyn Cr	845
stat Cor	1080

Calculation factors

e	0.37
Y	1.6
Y0	0.9

Abutment and fillet

dimensions(mm)

Da max	219
db min	198

Single Row Tapered Roller Bearings (Metric Series)

Da min	326
Db min	344
Ca min	--
Cb min	--
Mass (kg)	33.5