

30256

Dimensions and Parameters

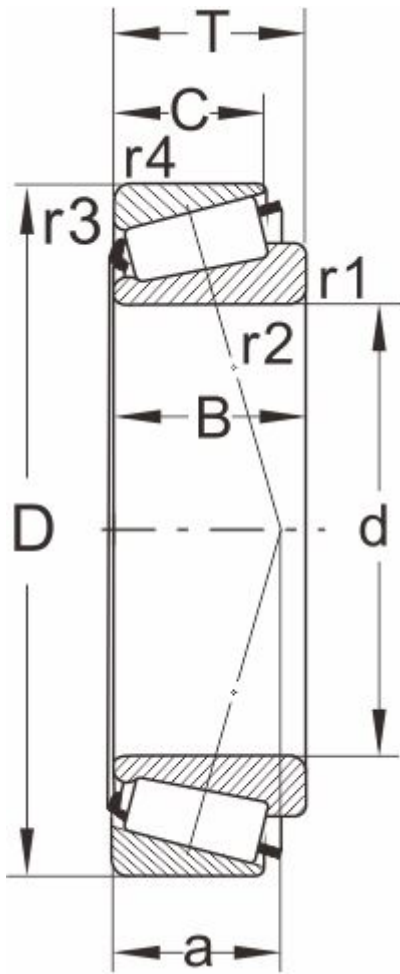

Designation

DIN720	30256
ISO355	--

Boundary dimensions(mm)

d	280
D	500
B	80
C	67
T	89
r1,r2 min	6
r3,r4 min	5
a	--

Speed ratings

grease	700
oil	950

Load ratings[kN]

dyn Cr	1240
stat Cor	1900

Calculation factors

e	0.44
Y	1.4
Y0	0.74

Abutment and fillet

dimensions(mm)

Da max	336
db min	313

Single Row Tapered Roller Bearings (Metric Series)

Da min	456
Db min	478
Ca min	--
Cb min	--
Mass (kg)	66.3