

3012B.2RSR

Dimensions and Parameters

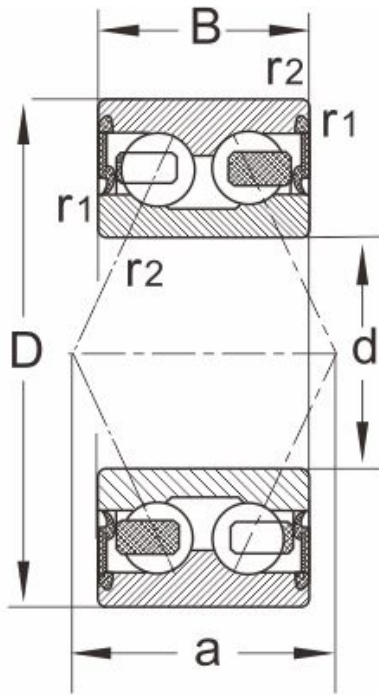

30..B.2RSR,32..B.2RSR
 33..B.2RSR,38..B.2RSR
 39..B.2RSR

Designations	3012B.2RSR
Boundary dimensions	
d	60
D	95
B	26
r1,r2 Min	1.1
a ≈	--
Load ratings[KN]	
Dynmic Cr	47.2
stat Cor	53.4
Speed ratings[rpm]	
grease	4400
oil	--
Mass	0.621