

Dimensions and Parameters

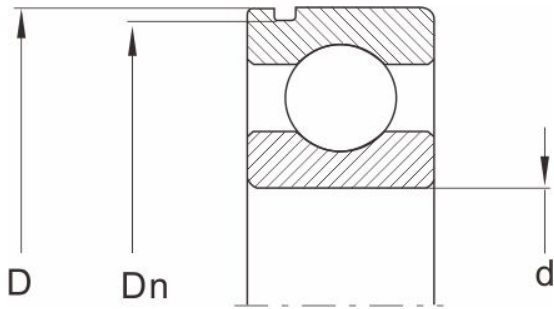

Designation Bearing series

60	--
62	62/32N
63	--
64	--
D	65

Dn

min.	62.1
max.	62.6

a Bearing series 60

min.	--
max.	--

a Bearing series 62 63 64

min.	3.08
max.	3.28

b

min.	1.9
max.	2.2

r0

max.	0.6
------	-----

Stop ring

D	SP65
---	------

f

min.	1.6
max.	1.7

e

Single Row Deep Groove Ball Bearings with Snap Ring Groove and Snap

Ring

min.

3.89

max.

4.04

g

≈

4

DR

max

70.7

DG

min

71.5