

Dimensions and Parameters

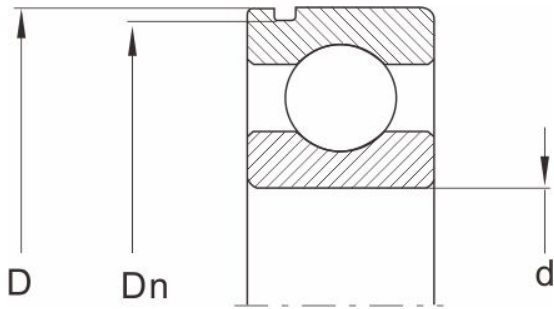

Designation Bearing series

60	--
62	6203N
63	--
64	--
D	40

Dn

min.	37.85
max.	38.1

a Bearing series 60

min.	--
max.	--

a Bearing series 62 63 64

min.	1.91
max.	2.06

b

min.	1.35
max.	1.65

r0

max.	0.4
------	-----

Stop ring

D	SP40
---	------

f

min.	1.02
max.	1.12

e

Single Row Deep Groove Ball Bearings with Snap Ring Groove and Snap

Ring

min.

3.1

max.

3.25

g

≈

3

DR

max

44.6

DG

min

45.5